



DILE

x - l i g h t

X-LIGHT representa la renovación, tanto en DILE, como en lo que significa una silla en un entorno de trabajo.

Claramente habla al presente desde el futuro, aportando innovación desde todos los ángulos.



x - l i g h t



# x - light

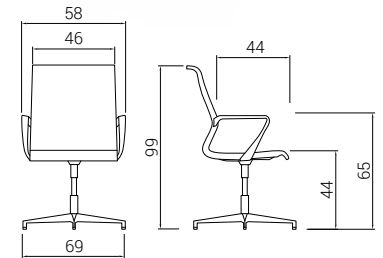
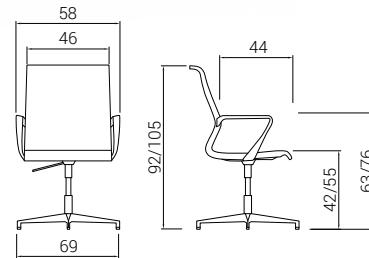
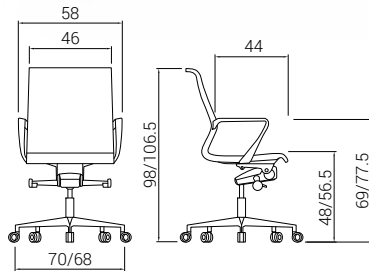
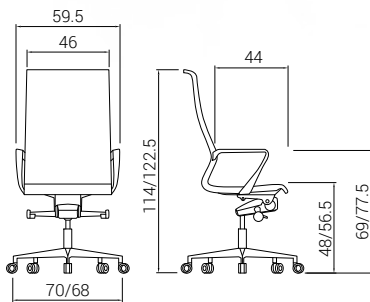

# x - light



## Sillón alto | S0000-0612-xyy

Referencia	Base	Ruedas Huecas EMILSIDER	Brazos	Mecanismo
S2600	aluminio pulido	huecas/goma	nylon	basculante avanzado
S2601	nylon blanco	huecas/goma	nylon	basculante avanzado
S2602	nylon negro	huecas/goma	nylon	basculante avanzado
S2603	aluminio pulido	huecas/goma	nylon	elevación a gas
S2604	nylon blanco	huecas/goma	nylon	elevación a gas
S2605	nylon negro	huecas/goma	nylon	elevación a gas

Unidades 1 / Peso 14,50 Kg / Volumen 0,23 m<sup>3</sup>



## Sillón bajo | S0000-0612-xyy

Referencia	Base	Ruedas Huecas EMILSIDER	Brazos	Mecanismo
S2606	aluminio pulido	huecas/goma	nylon	basculante avanzado
S2607	nylon blanco	huecas/goma	nylon	basculante avanzado
S2608	nylon negro	huecas/goma	nylon	basculante avanzado
S2609	aluminio pulido	huecas/goma	nylon	elevación a gas
S2610	nylon blanco	huecas/goma	nylon	elevación a gas
S2611	nylon negro	huecas/goma	nylon	elevación a gas

Unidades 1 / Peso 13,50 Kg / Volumen 0,23 m<sup>3</sup>



## Confidente | S0000-0612-xyy

Referencia	Base	Tapones	Brazos	Mecanismo
S2612	4 radios aluminio pulido	tapones	nylon	sistema revolving
S2613	4 radios aluminio blanco	tapones	nylon	sistema revolving
S2614	4 radios aluminio negro	tapones	nylon	sistema revolving
S2615	4 radios aluminio pulido	tapones	nylon	elevación a gas
S2616	4 radios aluminio blanco	tapones	nylon	elevación a gas
S2617	4 radios aluminio negro	tapones	nylon	elevación a gas

Unidades 1 / Peso 12,30 Kg / Volumen 0,25 m<sup>3</sup>

### color estructura (xx)

01	blanco
02	negro

### color malla (yy)

01	blanco
02	negro
18	rojo
22	gris
27	azul marino

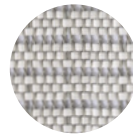

01 / Blanco



02 / Negro

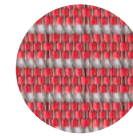

18 / Rojo

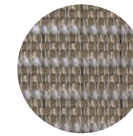

22 / Gris

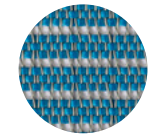

27 / Azul marino

Referencia	Características
A004	Entrega silla semimontada
A006	Entrega silla montada



Peso máximo

CERTIFICADOS Y NORMATIVAS

UNE EN 1335:2001 partes 1, 2 y 3

